

MILA

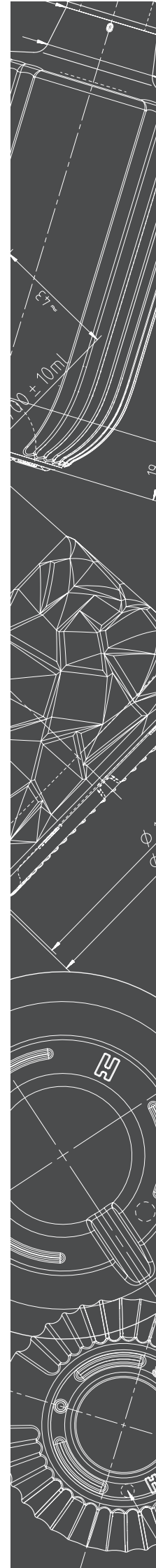

HRASTNIK1860



HRASTNIK1860

Designed for Steklarna Hrastnik. All rights reserved.

MILA 50 ml BVP 18

Drawing No.		Brimful capacity	54 ± 3 ml
Volume	50 ml / 1,19 oz	Pieces on pallet	792x6=4752
Weight	86 g / 0,19 lbs	Weight of pallet	465 kg
Finish	BVP 18	Height of pallet	1,04 m

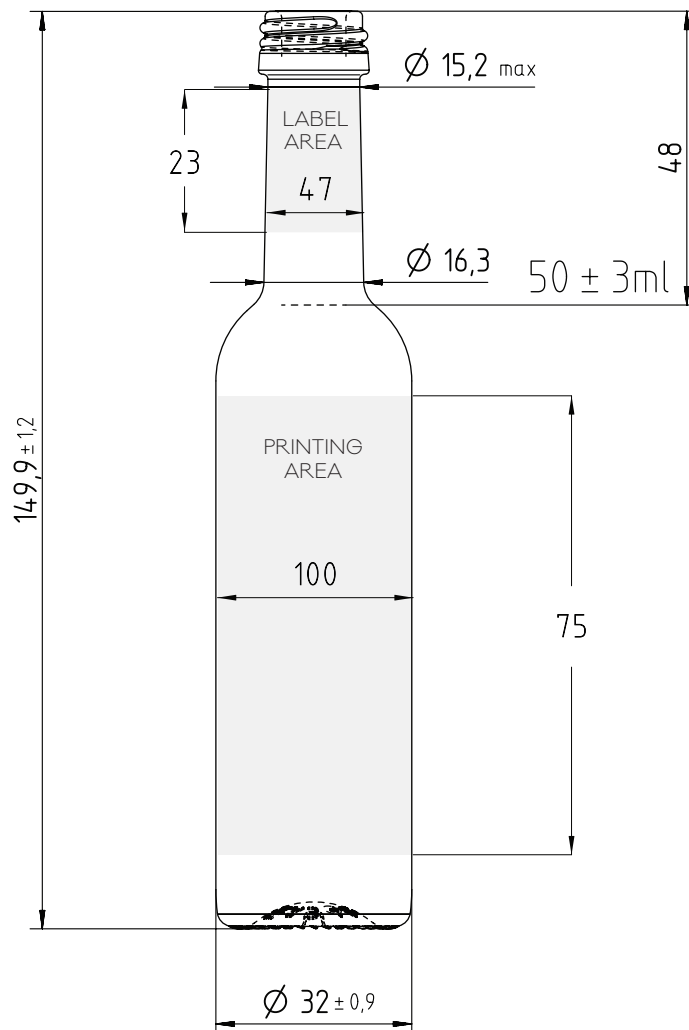
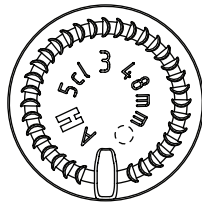

HRASTNIK1860

STEKLARNA HRASTNIK d.o.o. / Cesta 1. maja 14 / 1430 Hrastnik / SLOVENIA
www.hrastnik1860.com

HRASTNIK1860

Designed for Steklarna Hrastnik. All rights reserved.

MILA

 350 ml F14

Drawing No.	7055007	Brimful capacity	362 ± 6 ml
Volume	350 ml / 11,80 oz	Pieces on pallet	340x7=2380
Weight	350 g / 0,77 lbs	Weight of pallet	655 kg
Finish	F14	Height of pallet	2,05 m

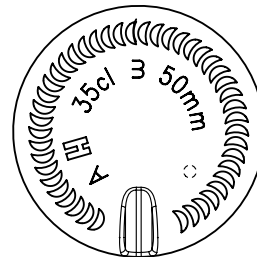
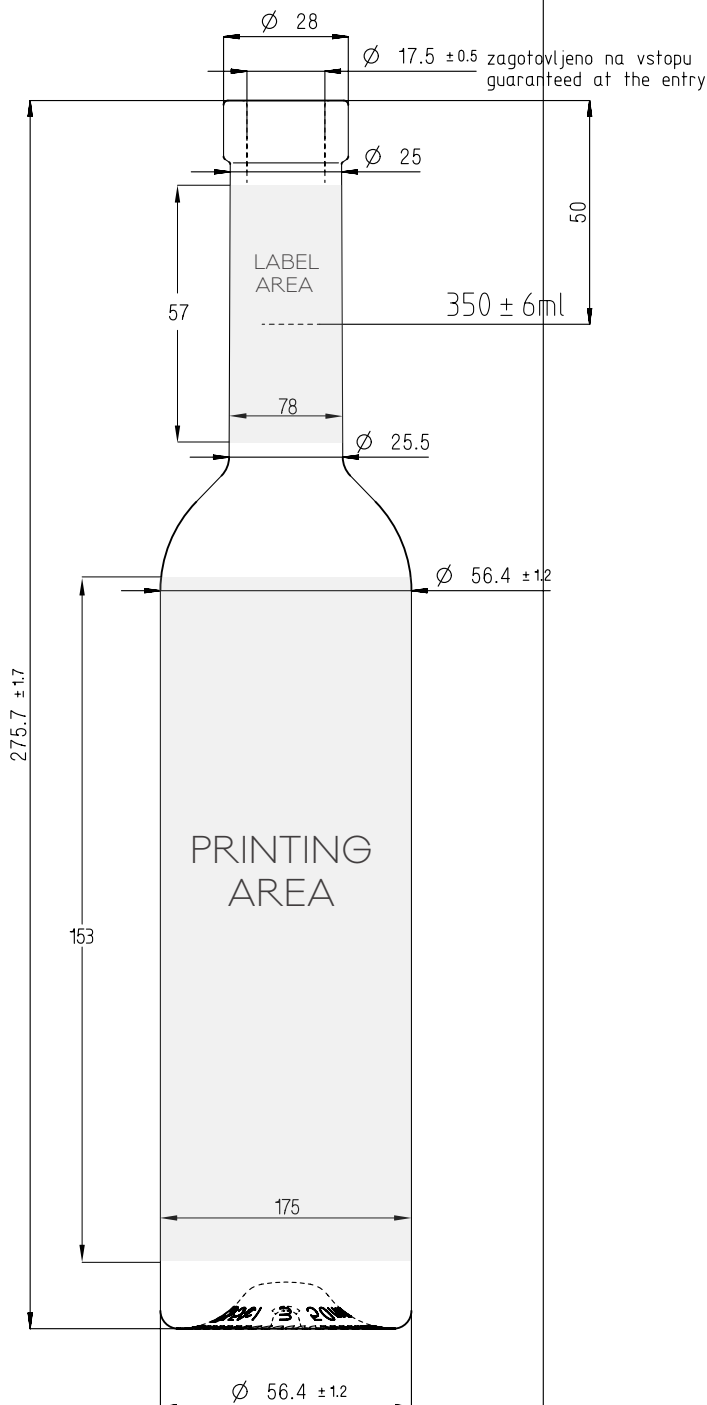

HRASTNIK1860

STEKLARNA HRASTNIK d.o.o. / Cesta 1. maja 14 / 1430 Hrastnik / SLOVENIA
www.hrastnik1860.com

HRASTNIK1860

Designed for Steklarna Hrastnik. All rights reserved.

MILA 500 ml F14

Drawing No.	7055010	Brimful capacity	520 ± 10 ml
Volume	500 ml / 16,91 oz	Pieces on pallet	238x3=714
Weight	500 g / 1,10 lbs	Weight of pallet	401 kg
Finish	F14	Height of pallet	1,1 m

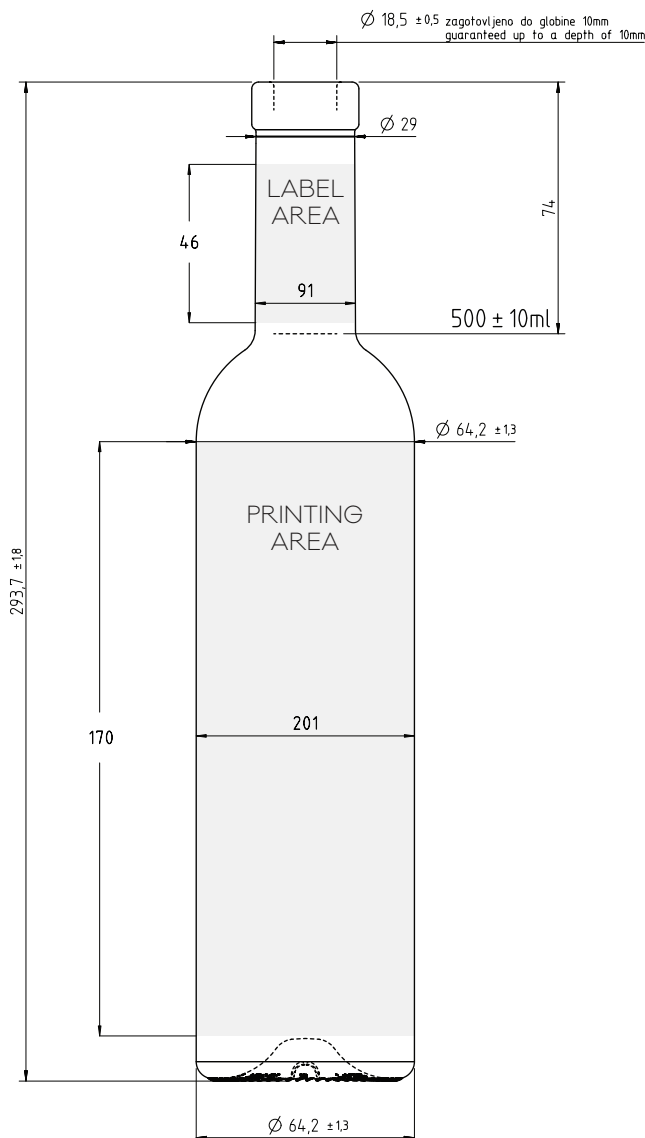
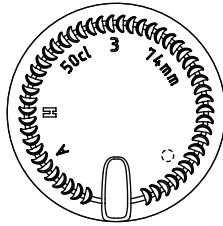

HRASTNIK1860

STEKLARNA HRASTNIK d.o.o. / Cesta 1. maja 14 / 1430 Hrastnik / SLOVENIA
www.hrastnik1860.com

HRASTNIK1860

Designed for Steklarna Hrastnik. All rights reserved.

MILA

 700 ml F14

Drawing No.	7055001	Brimful capacity	722 ± 10 ml
Volume	700 ml / 23,70 oz	Pieces on pallet	208x6=1248
Weight	560 g / 1,23 lbs	Weight of pallet	750 kg
Finish	F14	Height of pallet	2,19 m

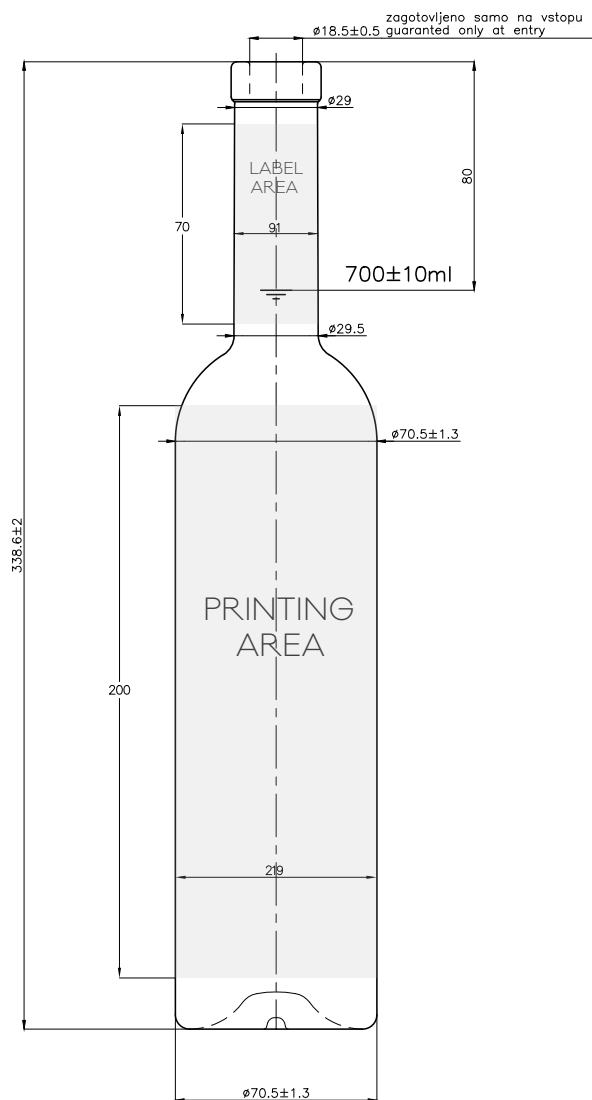

Pogled dna
Bottom view

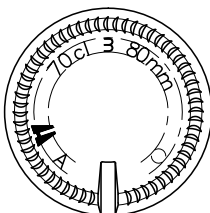

HRASTNIK1860

STEKLARNA HRASTNIK d.o.o. / Cesta 1. maja 14 / 1430 Hrastnik / SLOVENIA
www.hrastnik1860.com

HRASTNIK1860

Designed for Steklarna Hrastnik. All rights reserved.

MILA

 750ml F14

Drawing No.	7055003	Brimful capacity	772 ± 10 ml
Volume	750 ml / 25,4 oz	Pieces on pallet	1248=208x6
Weight	600 g / 1,32 lbs	Weight of pallet	750kg
Finish	F14	Height of pallet	2,19 m

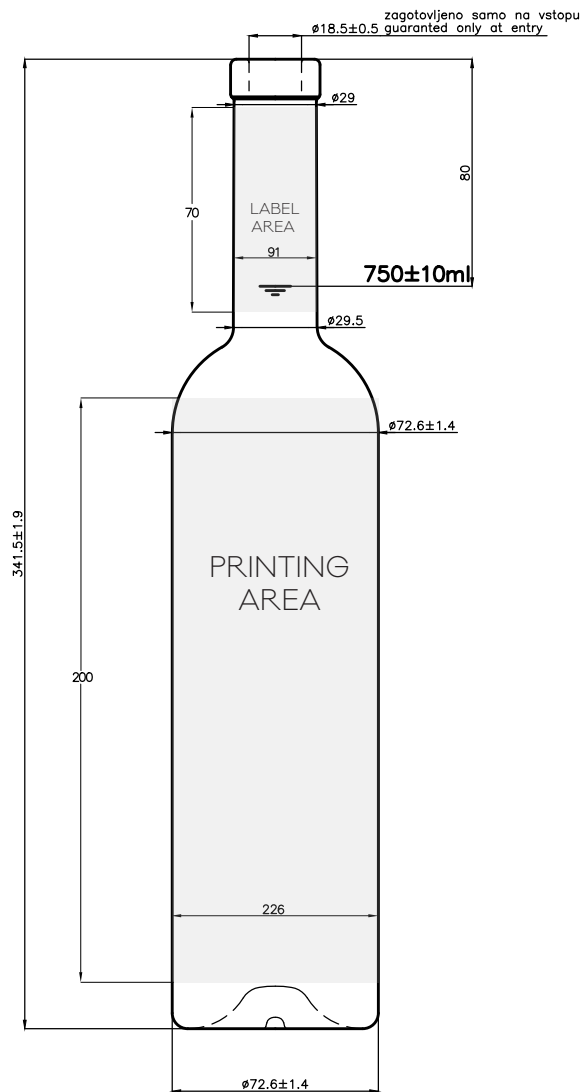

Pogled dna
Bottom view

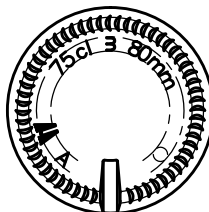

HRASTNIK1860

STEKLARNA HRASTNIK d.o.o. / Cesta 1. maja 14 / 1430 Hrastnik / SLOVENIA
www.hrastnik1860.com

HRASTNIK1860

Designed for Steklarna Hrastnik. All rights reserved.

MILA

 750 ml GPI

Drawing No.	7055002	Brimful capacity	772 ± 10 ml
Volume	750 ml / 25,40 oz	Pieces on pallet	208x6=1248
Weight	600 g / 1,32 lbs	Weight of pallet	750 kg
Finish	GPI 400/28	Height of pallet	2,19 m

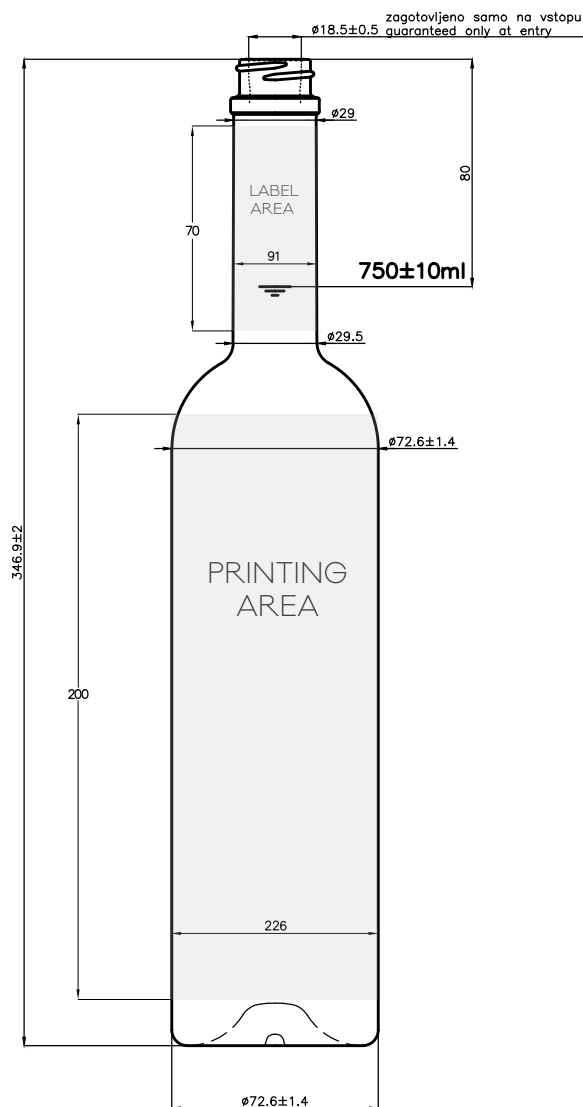

Pogled dna
Bottom view

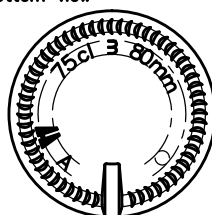

HRASTNIK1860

STEKLARNA HRASTNIK d.o.o. / Cesta 1. maja 14 / 1430 Hrastnik / SLOVENIA
www.hrastnik1860.com

HRASTNIK1860

Designed for Steklarna Hrastnik. All rights reserved.

MILA

 1000 ml F15,5

Drawing No.	7055005	Brimful capacity	1030±10 ml
Volume	1000 ml / 33,80 oz	Pieces on pallet	168x5=840
Weight	740 g / 1,63 lbs	Weight of pallet	685 kg
Finish	F15,5	Height of pallet	2,02 m

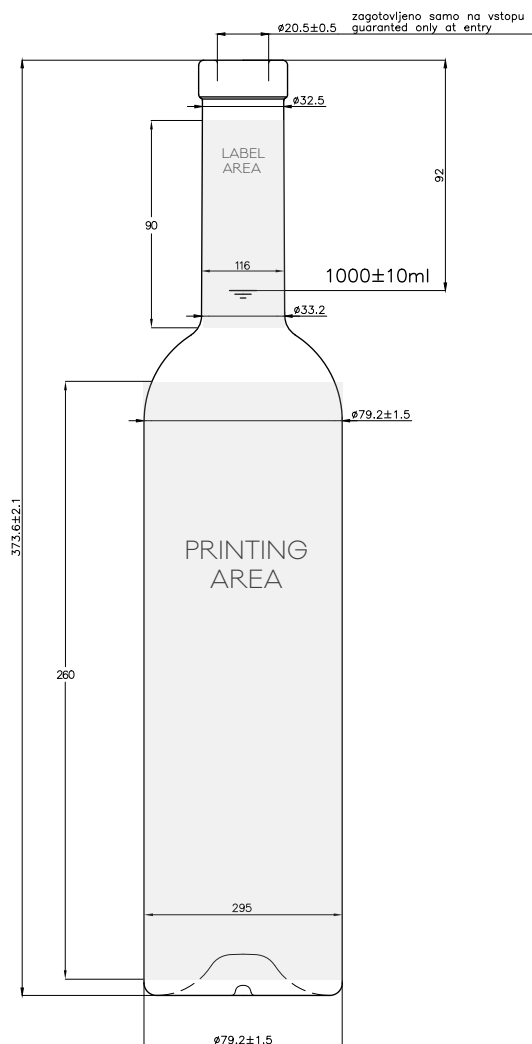

Pogled dna
Bottom view

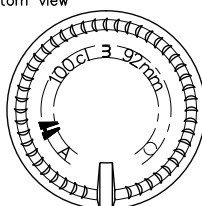

HRASTNIK1860

STEKLARNA HRASTNIK d.o.o. / Cesta 1. maja 14 / 1430 Hrastnik / SLOVENIA
www.hrastnik1860.com

HRASTNIK1860

Designed for Steklarna Hrastnik. All rights reserved.

MILA

 1000 ml GPI

Drawing No.	7055004	Brimful capacity	1032 ±10 ml
Volume	1000 ml / 33,80 oz	Pieces on pallet	168x5=840
Weight	740 g / 1,63 lbs	Weight of pallet	685 kg
Finish	GPI 400/33	Height of pallet	2,02 m

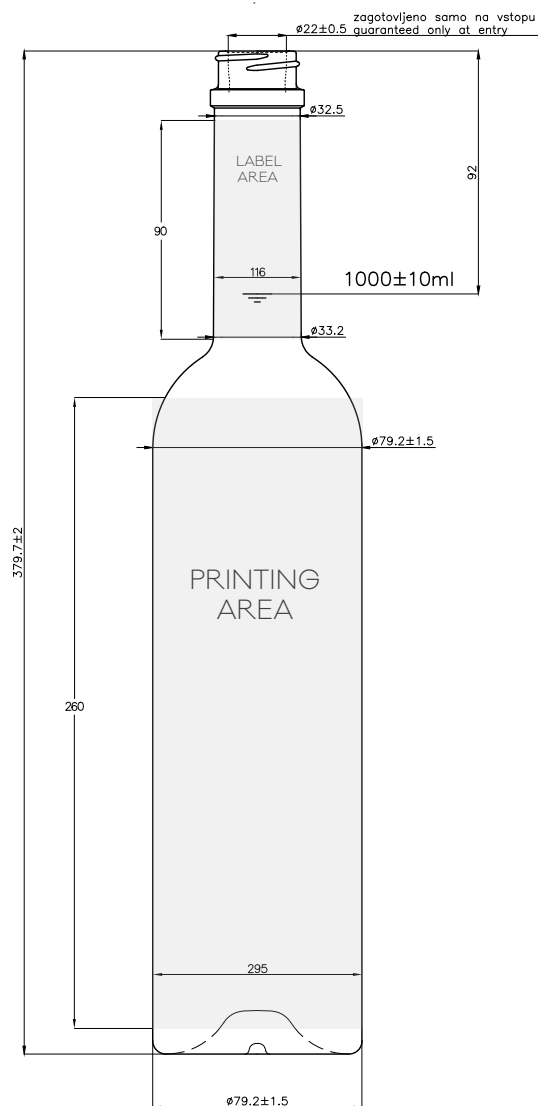

Pogled dna
Bottom view

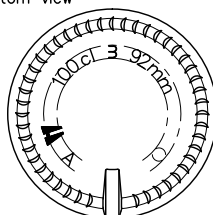

HRASTNIK1860

STEKLARNA HRASTNIK d.o.o. / Cesta 1. maja 14 / 1430 Hrastnik / SLOVENIA
www.hrastnik1860.com

HRASTNIK1860

Designed for Steklarna Hrastnik. All rights reserved.

MILA

 1750 ml F16

Drawing No.	7055009	Brimful capacity	1810 ± 10 ml
Volume	1750 ml / 59,2 oz	Pieces on pallet	120x4=480
Weight	1200 g / 2,65 lbs	Weight of pallet	616 kg
Finish	F16	Height of pallet	1,95 m

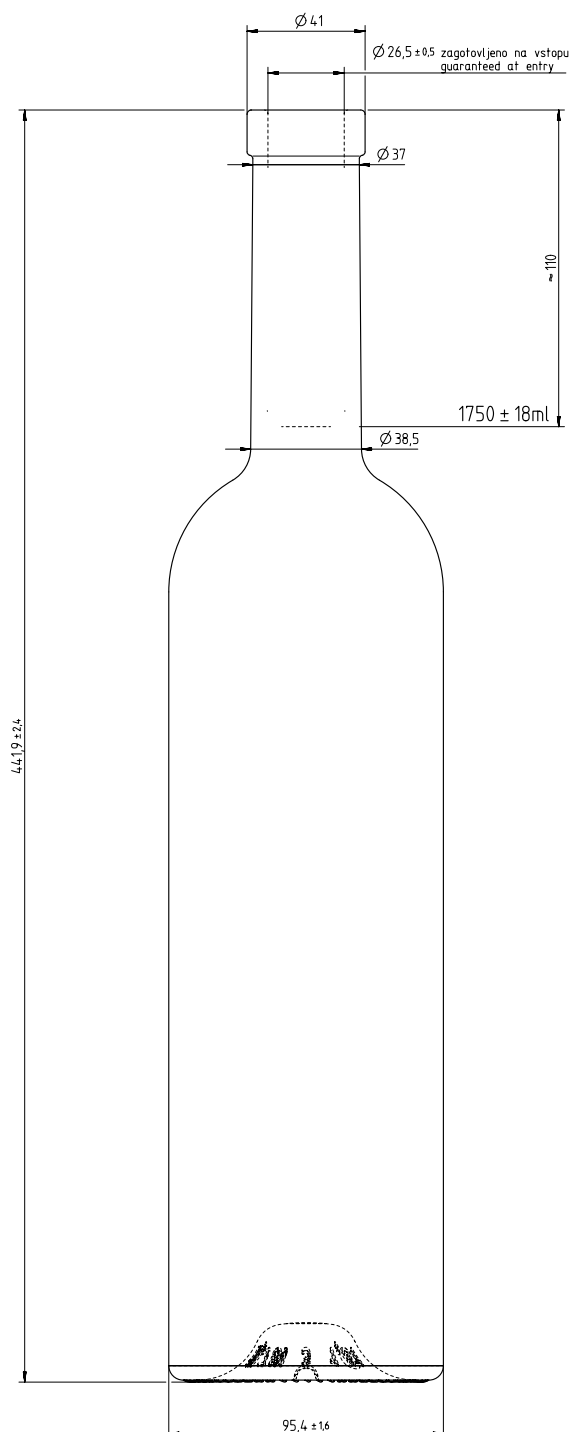

POGLED DNA
BOTTOM VIEW

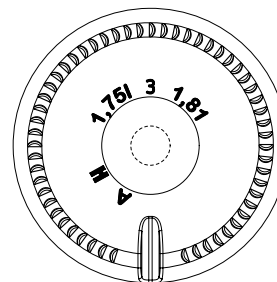

HRASTNIK1860

STEKLARNA HRASTNIK d.o.o. / Cesta 1. maja 14 / 1430 Hrastnik / SLOVENIA
www.hrastnik1860.com

HRASTNIK1860

Designed for Steklarna Hrastnik. All rights reserved.

MILA

 1750 ml GPI

Drawing No.	7055006	Brimful capacity	1802± 10 ml
Volume	1750 ml / 59,2 oz	Pieces on pallet	120x4=480
Weight	1230 g / 2,71 lbs	Weight of pallet	643 kg
Finish	GPI 400/Special	Height of pallet	1,97 m

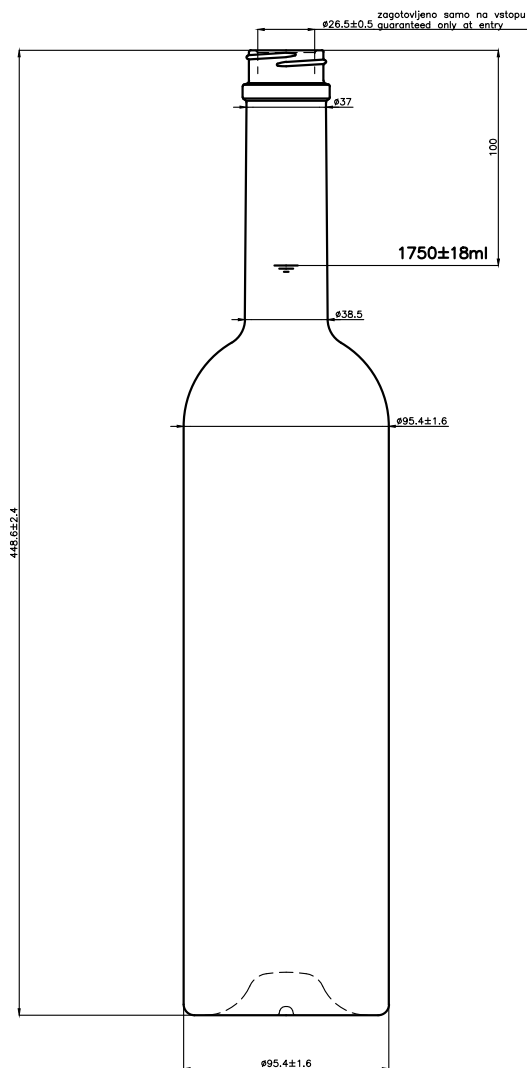

Pogled dna
Bottom view

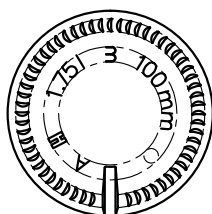

HRASTNIK1860

STEKLARNA HRASTNIK d.o.o. / Cesta 1. maja 14 / 1430 Hrastnik / SLOVENIA
www.hrastnik1860.com